

---

# SF6气体密度继电器

---

## SF6 气体应用

当高压断路器(又称高压开关)在开断电路时会有火花产生又称之为电弧，在电气设备中电弧的产生会对断路器造成烧毁甚至发生爆炸的危害。SF6 气体由于具有绝缘性能好灭弧能力强的特性，目前在高压断路器中被广泛使用。

SF6 气体在电力设备中的灭弧性能取决于设备容器中的 SF6 气体的密度。如在不同型号、规格的断路器中的 SF6 气体的密度就是不相同的，如果 SF6 气体由于泄漏，密度减小，则灭弧作用就会减弱或起不到灭弧作用，因此，用 SF6 密度表对容器内 SF6 气体的密度进行监视和控制就显得格外重要。

## SF6 gas intended

The spark happened when the electric switching or the high pressure breaker (high pressure switch) open or close circuit is the electric arc. The electric arc produced in the electrical equipment may lead the circuit breaker to burn down even explosive. The SF6 gas is widely used in the high-pressured electric appliance because it has the insulating ability of extinguishing arc.

The ability of The SF6 gas extinguishing arc has big relations with the SF6 gas density in the equipment vessel. In the different model, specification circuit breaker SF6 gas density is different, when the density SF6 gas is lower than some value, the extinguishing arc function is weaken, therefore, it is important that carrying on the surveillance and the control of the SF6 gas density .

---

## SF6 密度表原理与应用

SF6 密度表，有“YM (M1)” T-P 曲线监测，“YWM (M2)” 温度补偿监测；“YXM (M3)” 温度补偿加控制装置三大系列产品。

“YM (M1)” T-P 曲线监测系列密度表的原理与应用

T-P 曲线监测 SF6 气体的密度，是将一定额定工作压力下的 SF6 温度 - 压力对照情况用一条曲线在表盘上表示出来，让人们从表盘上方便和直观地来监测 SF6 气体的密度情况，带这种曲线盘的压力表，称之为 T-P 曲线的密度表。

一般情况下，表盘上是由 3 条 T-P 曲线组成，从左至右我们依次叫他们为“左曲线”、“中曲线”、“右曲线”，其中“左曲线”和“右曲线”将表盘分为 3 个区域，“左曲线”的左边为红色区域、“左曲线”和“右曲线”之间为绿色区域、“右曲线”的右边为黄色区域(如图)

## SF6 densimeter principle & intended

Beijing The SF6 densimeter made of BRIGHT has three big series products : "YM (M1)" T-P curve monitor; "YM (M2)" temperature compensation monitor, "YXM (M3)" temperature compensation with control device.

"YM (M1)" the T-P curve monitor series densimeter principle and service intended

Under the fixed working pressure, a curve on the dial plate shows the SF6 temperature- pressure comparison situation to let the people conveniently and direct-viewing monitors the SF6 gas density situation from the dial plate.

In the ordinary circumstances, the dial plate is composed by 3 T-P curves, they are "the left curve", "center the curve", "the right curve" from left to right, "the left curve" and "the right curve" divides the dial plate into 3 regions, "left curve" left side for red region, "left curve" and "right curve" between for green region, "right curve" right side for yellow region (as chart).

在用“表盘上带T-P曲线”的密度表对容器内SF6气体密度进行监视时,应首先测试环境温度,然后找出环境温度半圆线与指针的相交点A,若相交点A在绿色区域内,则表明器内SF6气体密度在规定的范围内;若相交点在红色区域内,则表明器内SF6气体密度低于规定的范围,应当补气或检查容器是否有泄漏发生。

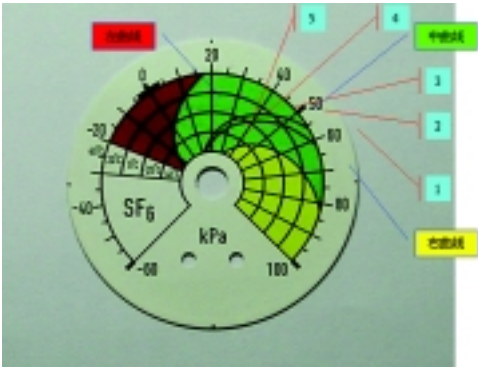

When using the densimeter " with T-P curve on the dial plate", you should read the thermometer nearby the densimeter to find out the ambient temperature, then find the point of intersection A of the ambient temperature half-circle line and the pointer, if A is in green region, then the SF6 gas density is in stipulation scope; If A is in red region, then the SF6 gas density is lower than the stipulation scope, it is necessary to restore vital energy or inspect the vessel whether has divulges occurs.

“ PWM (M2) ”温度补偿监测密度表的原理与应用

"YWM (M2)" temperature compensation monitor series densimeter principle and service intended

“带温度补偿装置”密度表是在原压力仪表结构上,加装温度补偿装置所组成。是一种不用考虑环境温度的变化(即不用查看温度计),也不用查看“对照表”,而是直接从密度表的读数就可以判断出容器内的SF6气体的密度是否在规定的范围内。

The densimeter "with temperature compensation" installs the temperature compensation in the initial pressure measuring structure. It does not need to consider ambient temperature change ( not need to see the thermometer), also does not need to look over "the comparative table", but is directly judge the SF6 gas density whether in stipulation scope.

工作原理是:当环境温度上升时,虽然容器内SF6气体的密度未发生变化但其压力增大,带动指针顺时针方向转动,而当温度上升时,双金属补偿装置的“U形”口张大,则推动指针向逆时针方向转动,当两种运动引起表针的偏转量相抵销时,无论环境温度如何变化,指针都不会发生偏转。反之,当环境温度下降时,虽然容器内SF6气体的密度未发生变化但其压力减小,带动指针向逆时方向转动,而当温度下降时,双金属补偿装置的“U形”口缩小,则推动指针向顺时针方向转动,当两种可运动个起表针的偏转量相抵销时,无论环境温度如何变化,指针都不会发生偏转。所以只要容器内SF6气体不发生泄漏,其密度不变化。仪表的示值就不变。从而达到测量和监视其密度的作用。其使用方法是:在20 的环境下,将容器内的SF6气体充至额定工作压力(P额),在每日的规定监测时间进行监测时,只要密度表的指针指向额定工作压力即

The principle of work is: When ambient temperature rises, the pressure of the SF6 gas increases, drives the indicator along the clockwise rotation, but at the same time, the mouth of the bimetal compensation system "the U shape" publicizes, then impels the indicator to the counter clockwise rotation, when two kind of strength be equilibrium, the ambient temperature change cannot made the indicator deflection. Otherwise, When ambient temperature falls, the pressure of the SF6 gas decreases, drives the indicator counter the clockwise rotation, but at the same time, the mouth of the bimetal compensation system "the U shape" reduces, then impels the indicator to along the clockwise rotation, when two kind of strength be equilibrium, the ambient temperature change cannot made the indicator deflection. So the SF6 gas does not occur divulges, its density does not change. Although pressure in the vessel changes along with the ambient temperature change, under the function of

为正常状态。

the bimetal piece "temperature compensation installment", the densimeter indicator cannot have deflection. Thus the SF6 density value in the vessel is really reflected. Its application method is: ambient temperature under 20 , fill the SF6 gas to the fixed working pressure (P ), Monitor at regulate time daily, it is normal while the indicator pointing the fixed working pressure.

### PXM (M3) 温度补偿加控制装置的密度控制器

### PXM (M3) temperature compensation with control device density controller

当“PXM (M3)”型 SF<sub>6</sub> 气体密度控制器接入密闭系统后，向系统设备中充入 SF<sub>6</sub> 气体，当 SF<sub>6</sub> 气体密度达到规定值时，密度控制器的指针指向额定工作压力。当工作环境温度发生变化时，虽然 SF<sub>6</sub> 气体的密度并没有发生变化，但 SF<sub>6</sub> 气体的压力将随着温度的变化而改变，密度控制器上的指针本应随压力的改变而发生偏转，此时通过控制器内部的温度补偿装置对 SF<sub>6</sub> 气体压力的变化进行补偿，使指针不发生偏转。只有在系统中 SF<sub>6</sub> 气体发生泄漏，造成密度下降时，SF<sub>6</sub> 气体密度控制器的指针才发生偏转，从而起到对系统中 SF<sub>6</sub> 气体密度的监测作用。

"PXM (M3)" SF6 density controller has installed electric contact device based on the "M2" densimeter. The two contact points is warning point and closedown point. So SF6 density controller can not only monitor but also warn and close automatically. When SF6 gas divulges, internal pressure reduces along with the density of SF6 gas reducing, causes the indicator contact (move touch) with the lower limit point (fixed touch) to send out the alarm, continues along with the density of SF6 gas reducing, the pressure continues to drop, when on the indicator contact (move touch) with the closedown point (fixed touch) to shut-off circuit breaker switch automatically, to prevented the accident occurred.

SF<sub>6</sub> 气体密度控制器 通常配置两个设定开关点 Ps1 和 Ps2，设定点 Ps1 为报警点，设定点 Ps2 为闭锁点。一旦系统发生 SF<sub>6</sub> 气体泄漏时，随着 SF<sub>6</sub> 气体密度降低，指针上的触头（动触头）与设定开关点 Ps1 上的触头（定触头）接触时则发出报警信号；随着密度继续下降，当指针触头与设定点 Ps2 上的触头接触时，则发出闭锁信号，自动关闭断路器开关，使之不能工作，防止事故的发生。



# SF6 气体密度控制器

# PXM-100

## SF6 Density Monitor

仪表充油、不充油可选

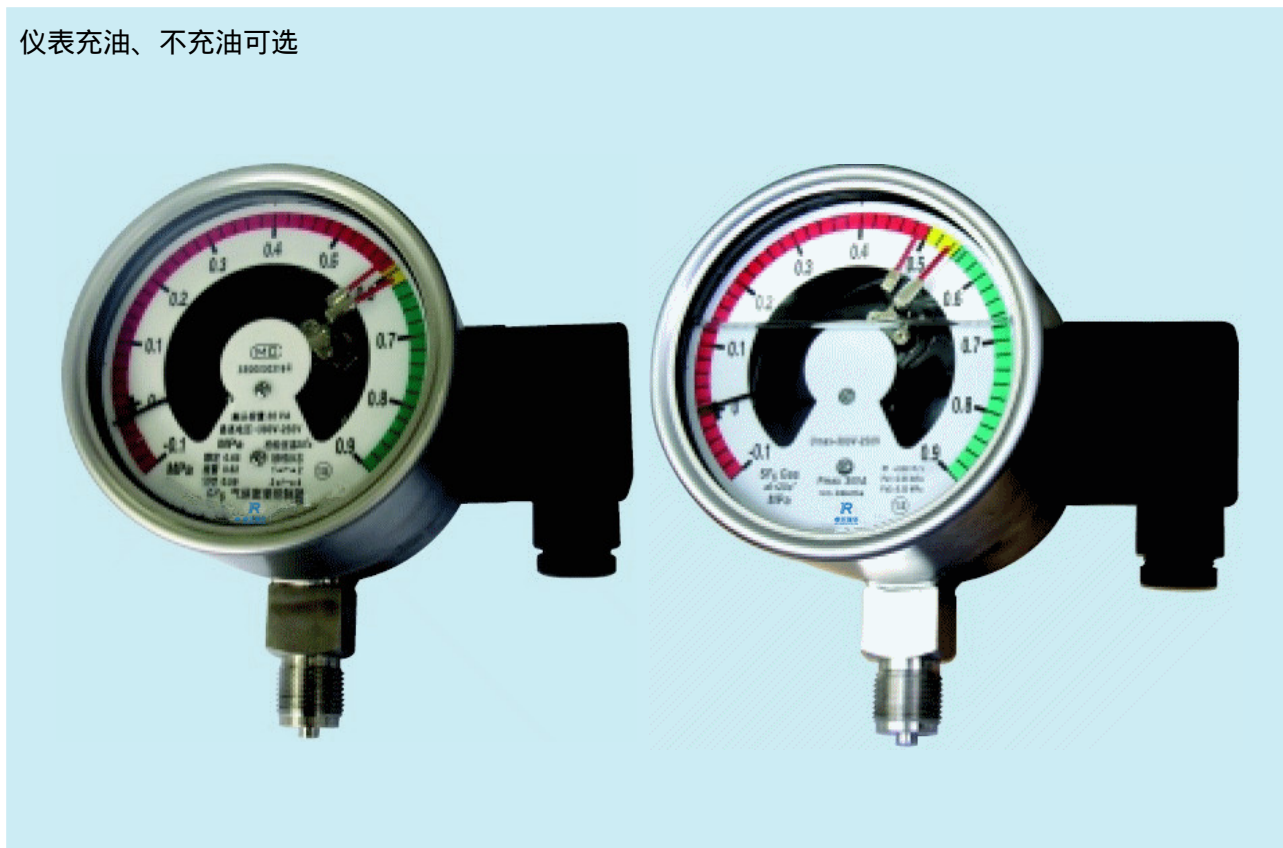

| 安装结构 Mounting   | 类型 Type                              | 型号标示 Type code   |
|---|--------------------------------------|--|
| 径向<br>Bottom<br>mounting<br> | 标准型<br>Sealed<br>充液耐震型<br>Oil filled | PXM-100.AO.531 (YXCM-100)<br>PXMN-100.AO.531 (YXCNM-100)   |
| 轴向<br>Back<br>mounting<br>   | 标准型<br>Sealed<br>充液耐震型<br>Oil filled | PXM-100.BO.531(YXCM-100Z)<br>PXMN-100.BO.531(YXCNM-100Z)   |
| 轴向嵌装<br>Back<br>mounting<br> | 标准型<br>Sealed<br>充液耐震型<br>Oil filled | PXM-100.BT.531(YXCM-100ZT)<br>PXMN-100.BT.531(YXCNM-100ZT) |



## 技术参数

|         |                                   |
|---------|-----------------------------------|
| 精度等级    | 1.5级(-30-60 时), 2.5级(-40 时)       |
| 工作环境    | 温度 -30 ~ 60<br>(要求 -40 以上时在合同中注明) |
| 测量范围    | -0.1 ~ 0.9MPa; -0.1 ~ 0.6MPa      |
| 连接尺寸    | M20 × 1.5 (可按用户需求订制)              |
| 外型尺寸    | 145 × 136 × 88 (高 × 宽 × 厚) mm     |
| 触点功率    | 30VA / 50W                        |
| 最高电压    | AC380.DC220V                      |
| 最大电流    | 1A                                |
| 防护等级    | IP65                              |
| 仪表外径    | 100mm                             |
| 绝缘强度    | 2KV,50Hz (针对壳体内部电路)               |
| 密封性能    | $10^{-9}$ Pa.m <sup>3</sup> /s    |
| 耐冲击性能   | 300m/s <sup>2</sup>               |
| 耐工作环境振动 | V · H · 5 级                       |

## 主要部件材质

|      |             |
|------|-------------|
| 表外壳  | SUS304 不锈钢  |
| 接头   | SUS316 不锈钢  |
| 测压元件 | SUS316L 不锈钢 |
| 感温元件 | 双金属温度补偿器    |
| 机芯   | 不锈钢         |
| 表玻璃  | 安全玻璃        |
| 焊接方式 | 无氧焊接        |

## Technical Specifications

|                      |  |
|----------------------|--|
| Indication Accuracy: | Cl. 1.5 (-30-60 ) Cl. 2.5(-40 )                                    |
| Working condition:   | Temperature: -30-60<br>(Please write in the contract if over -40 ) |
| Spec:                | -0.1 ~ 0.9MPa; -0.1 ~ 0.6MPa                                       |
| Connection:          | M20 × 1.5 (or on request)  |
| Dimensions:          | 145 × 136 × 88   |
| Contact Rating:      | 30VA / 50W   |
| Max. Voltage:        | AC380.DC220V   |
| Max. Carrent:        | 1A   |
| Protection:          | IP65   |
| Diameter:            | 100mm  |
| Dielectric strength: | 2KV,50Hz (for circuit inside)                                      |
| Sealability:         | $10^{-9}$ Pa.m <sup>3</sup> /s                                     |
| Shockproof:          | 300m/s <sup>2</sup>  |
| Vibration-proof:     | V · H · 5 级  |

## Main Compowent Material

|                              |   |
|------------------------------|---|
| Case Material:               | SUS304 Stainless Steel                  |
| Socket:                      | SUS316 Stainless Steel                  |
| Pressure Measuring Element:  | SUS316L Stainless Steel                 |
| Temperature sensing element: | Double-metal<br>temperature compensator |
| Movement:                    | Stainless Steel                         |
| Window:                      | Safety glass                            |
| Welding :                    | Oxygen-free Welding                     |

## 定货说明：

1. 现场振动、冲击较大时应选用充液的密度控制器。
2. 定货时应注明:
  - (1).额定工作压力值
  - (2).报警压力值
  - (3).闭锁压力值

## Ordering information

1. Liquid filled density monitor should be used where vibrations and shocks exit.
2. When order specify following pressure values
  - (1) Working pressure value
  - (2) Alarm pressure value
  - (3) Lock pressure value

仪表几何尺寸 DIMENSIONS

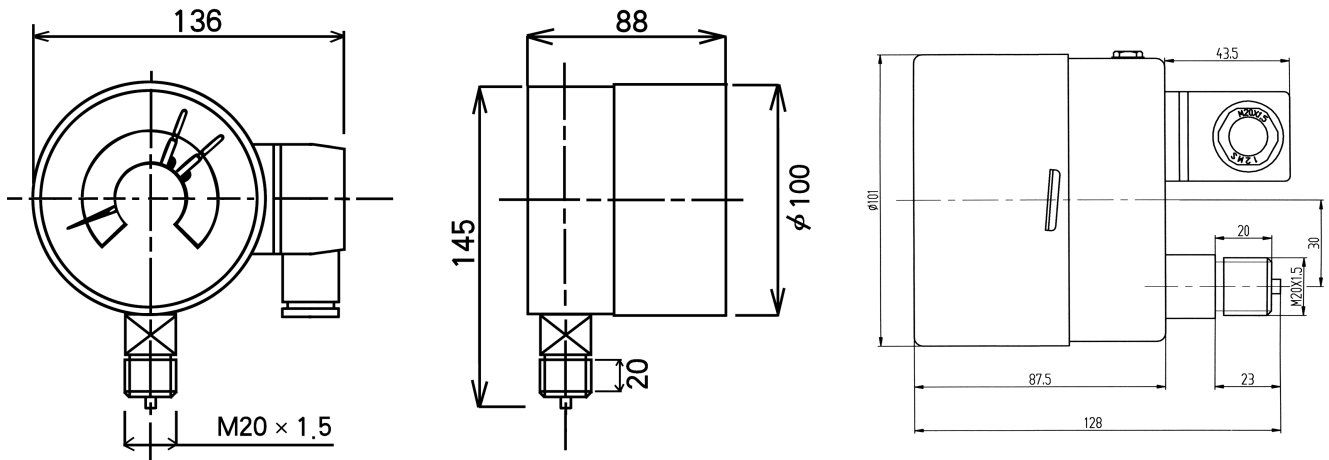

量程规格表 Range Table (单位 Unit : mm)

| 序号<br>No. | 额定压力<br>Pressure Rating | 报警压力<br>Alarm Pressure | 闭锁压力<br>Lock Pressure | 闭锁压力<br>Lock Pressure | 备注<br>Remark     |
|-----------|-------------------------|------------------------|-----------------------|-----------------------|------------------|
| 1         | 0.30                    | 0.25                   |                       |                       |                  |
| 2         | 0.35                    | 0.30                   |                       |                       |                  |
| 3         | 0.40                    | 0.35                   |                       |                       |                  |
| 4         | 0.40                    | 0.30                   |                       |                       |                  |
| 5         | 0.40                    | 0.35/0.35              |                       |                       | 双报警 Double Alarm |
| 6         | 0.40                    | 0.37                   | 0.35                  |                       |                  |
| 7         | 0.45                    | 0.38                   | 0.35                  |                       |                  |
| 8         | 0.50                    | 0.45                   |                       |                       |                  |
| 9         | 0.50                    | 0.45                   | 0.40                  |                       |                  |
| 10        | 0.50                    | 0.42                   | 0.40                  |                       |                  |
| 11        | 0.60                    | 0.57                   | 0.55                  |                       |                  |
| 12        | 0.60                    | 0.55                   | 0.50                  |                       |                  |
| 13        | 0.60                    | 0.55                   | 0.50                  | 0.50                  | 双闭锁 Double Lock  |
| 14        | 0.60                    | 0.52                   | 0.50                  |                       |                  |

型号标示 Model Indication:

YXMS-100

Here is YXMS-100 s electrical principle scheme.

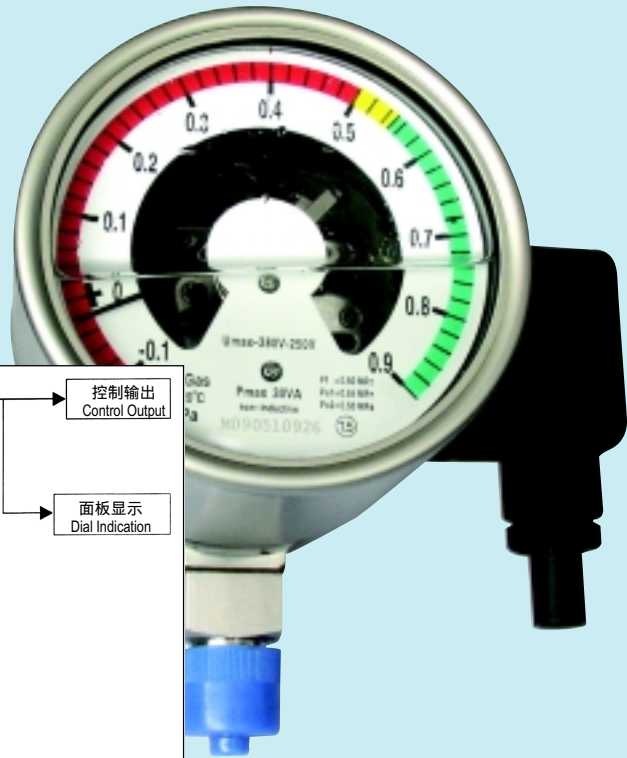
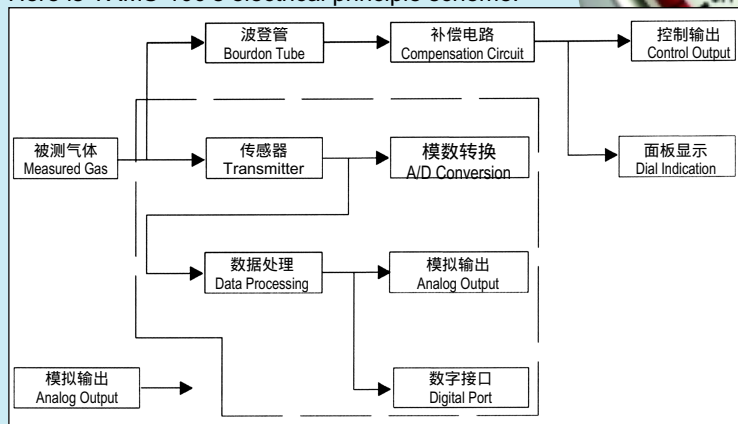

## 一、用途

PXMS-100 型 SF6 气体密度控制器 / 变送器主要应用于高压电气设备 (如高压断路器、互感器、GIS 等) 设备上, 仪表通过输出开关信号, 4~20mA 标准电流信号 (或直接给出 RS485 标准接口) 对高压电气设备内 SF6 气体的密度即可实现现场监测, 又可实现远程控制。

## 二、工作原理

PXMS-100 型密度控制器 / 变送器是我公司开发生产的新型 SF6 气体密度测量控制产品, 它采用了一种新型的机械电子技术融汇在一起。这一设计充分考虑了在使用现场的恶劣环境, 如高低温、强电磁干扰及强震动冲击对仪表的影响, 从而极大的提高了仪表的可靠性。仪表在设计上又考虑了在接入计算机测量系统时所必须的数字接口, 以适应现代测量的需要。

该仪表在原理上采用了双重测量原理设计, 首先将被测气体分为两路, 一路送入波登管, 另一路送入压力传感器。送入波登管的被测气体经过压力—密度转换补偿器件、传动器件推动指针在面板上直接显示压力值。另外, 在被测气体达到和触及设定的报警值时, 将直接驱动报警继电器的触点闭合, 以便将该信号输出。这一设计的优点是利用机械式密度控制器传感器对温度、震动和电磁干扰的不敏感性和滞后性,

## 1. Applications

PXMS-100 SF6 density controllers / transmitters are mainly used in high voltage electrical equipment (such as high voltage breakers, mutual inductors, GIS etc.) The instrument outputs switch signal, 4~20mA standard current signal (or directly to RS485 standard ports) to remotely control SF6 gas density.

## 2. Working Principle

Integrating mechanical and electrical means a combination of conventional SF6 density controller and electrical technology, PXMS-100 density controller / transmitter is a new SF6 gas density measuring and control instrument developed by our company. This new design eliminates the concern about harsh working environment like extreme temperature, high EMI and vibration, which may influence the instrument, therefore increases reliability greatly. Digital ports to computer measuring systems are provided to meet the requirement of modern measurement technology.

This instrument features dual measuring elements. The measured gas is split into 2 paths, one to the bourdon tube, the other to the pressure transmitter. The gas pressure is shown on the dial thru the bourdon tube, pressure-density conversion compensator and mechanism, and it directly closes the contact of alarm relay when

有效的提高了在室外恶劣环境下的可靠性，尤其对超高压电力开关开启、闭合时所引起的强电磁脉冲干扰。经实验，这一设计对强电磁干扰情况下采用电子器件所引起的密度控制器驱动系统误动作，有很大的提高和改进。另一方面，为了适应数字测量系统的需要，另一路被测气体送入压力传感器。从传感器输出的被测压力信号经放大、模数转换、数字补偿处理、送入数字接口，以现代数字测量技术所具有的标准数字接口和工业控制信号输出，形成测量系统。

新型的SF6密度控制器/变送器充分考虑了现场的需求以及抗强电磁干扰的特性，另外使用电子技术、微控制器、通讯等先进技术，即保留了机械式压力控制器稳定可靠的特点，又使得新型仪表具备了不可比拟的优越性。

PXMS-100 型密度控制器整机采用圆形结构，选用直径100mm × 127mm 外壳，具有测控准确、抗干扰性能强等优点。整机体积小、功能齐全、工作可靠、使用方便灵活。

PXMS-100 型数字密度控制器的电器工作原理见示意图。

被测量的SF6气体，首先由定制筛选的进口高精度压力传感器测量出压力信号。这一信号经过内部精确温度补偿，克服了由环境温度产生的偏差。然后经补偿的传感器输出信号送入A / D转换部分，A / D转换电路对传感器的输出信号进行不小于0.1%的高精度模数转换。经过转换的数字压力测量信号，再次被送入下一级即微处理器部分。微处理器对被测量的信号分别进行更精细的温度、线性补偿，并进行压力密度的转换计算。转换后的密度数字信号最后送入输出部分，输出部分为模拟输出和数字输出两种，模拟输出部分采用了数模转换原理，输出4 - 20 mA标准工业信号。数字输出部分则直接给出RS485标准接口。

整机的电源采用了传统的标准两线制供电方式，由外接的直流12 - 24 V电源模块供电。

### 三、技术指标

量程范围： $\left. \begin{array}{l} -0.1 \sim 0.9 \text{MPa} \\ -0.1 \sim 0.6 \text{MPa} \end{array} \right\}$  额定压力：0.3 - 0.6MPa  
报警压力 Ps1：用户要求  
闭锁压力 Ps2：用户要求

精确度： $\left. \begin{array}{l} \text{指示精度} \\ \text{信号精度} \end{array} \right\} \begin{array}{l} \pm 1.5\% \\ \pm 1.0\% \end{array}$

供电电源：DC12 ~ 24V

信号输出：0 ~ 0.9MPa(两线制4 ~ 20mA)

数字输出：RS485

使用环境温度：-30 ~ +60

相对湿度：95%

气压：(86 -- 106) kPa

长期稳定性： $\pm 1\% \text{FS} / \text{年}$

使用介质：SF6 气体

参数设置：通过专用软件设置

允许过载：小于等于量程的1.2倍(长期过载会降低传感器使用寿命)

震动冲击：50g

重量：1000g

连接：M20X1.5(或用户要求)

the gas reaches the set point. The advantages of the mechanical element are insusceptibility and hysteresis to temperature, vibration and EMI especially when superhigh voltage switches act, and these efficiently improve performance in outdoor harsh environment. Practices have proved this design prevents system's faulty function caused by EMI. On the other hand, to match digital measuring system, the pressure transmitter sends a signal out via magnifier, A/D convertor, digital compensator and standard digital ports of modern digital measurement technology, to build a measuring system.

The new SF6 density controller / transmitter takes care of on-site needs and high EMI, with electrical, micro-control, communication technologies, plus stable performance of the mechanical element, it gives the new instrument unmatched advantage.

PXMS-100 density controller is in round enclosure 100mm x 127mm, features accurate measurement and control, compact size, multi-function, reliability and easy use.

The customized & selected high accuracy pressure transmitter that we import overseas produces a pressure signal of SF6 gas. This signal is temperature compensated and free of temperature deflection. Then the compensated signal is sent to A/D unit for A/D conversion with accuracy better than 1%. After this conversion, the digital signal is sent to microprocessor for finer temperature and linearity compensations, and pressure/density conversion. Finally the digital density signal goes to output unit, which consists of analog output and digital output. The analog output is standard industrial 4~20mA signal based on D/A conversion, the digital output is RS485 port.

The instrument is powered by conventional 2-wire type of external 12~24VDC.

### 3. Technical Specifications:

Pressure Range： $\left. \begin{array}{l} -0.1 \sim 0.9 \text{MPa} \\ -0.1 \sim 0.6 \text{MPa} \end{array} \right\}$  Nominal Pressure: 0.3~0.6 MPa  
Alarm Pressure(Ps1): on request  
Lock Pressure(Ps2): on request

Accuracy： $\left\{ \begin{array}{l} \text{Indication: } \pm 1.5\% \\ \text{Signal: } \pm 1.0\% \end{array} \right.$

Power: DC 12~24V

Signal Output: 0~0.9 MPa (2-wire 4~20mA)

Digital Output: RS485

Ambient Temperature: -30~60 deg

Relative Humidity: 95%

Atmosphere: (86 -- 106) kPa

Long-term Stability:  $\pm 1\% \text{FS} / \text{year}$

Pressure Media: SF6 gas

Parameter Setup: Special setup software

Permissible Overload: Max 120% of pressure range (Long time overload may reduce life of the instrument)

Shock: 50g

Weight: 1000g

Connection: M20 x 1.5 or on request



#### 四、电器接口

本产品采用防水四芯航空插头。接线方式如下：

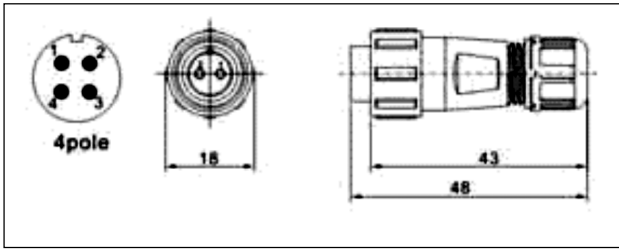

#### 4. Electrical Connection

4-pole aeronautic socket, wiring as below:

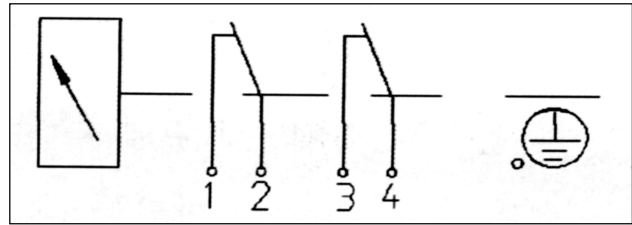

Ps1= 1-2

Ps2= 3-4

#### 五、数字接口

PXMS-100 型密度控制器配备 RS485 数字接口，通过数字接口可以实现远程数据读取，远程控制等功能。

接口协议如下：

#### 5. Digital Port

PXMS-100 is equipped with RS485 digital port, remote calibration and data access are realized via this digital port.

Port protocols as below:

##### 1. 温度读取 Temperature Reading

| 起始字符<br>Initial<br>Character | 地址<br>Add<br>-ress | 命令<br>Com<br>-mand | 数据 1<br>Datum<br>1 | 数据 2<br>Datum<br>2 | 数据 3<br>Datum<br>3 | 数据 4<br>Datum<br>4 | 数据 5<br>Datum<br>5 | CRC16 校验码<br>Verification<br>Code | CRC16 校验码<br>Verification<br>Code |
|------------------------------|--------------------|--------------------|--------------------|--------------------|--------------------|--------------------|--------------------|-----------------------------------|-----------------------------------|
| 0x55                         | 0xFF               | 0x40               | 0x 00              | 0x 00              | 0x 00              | 0x 00              | 0x 00              | 0xCF                              | 0x1A                              |

##### 返回值为 Returned Value

| 起始字符<br>Initial<br>Character | 地址<br>Add<br>-ress | 命令<br>Com<br>-mand | 数据 1<br>Datum<br>1 | 数据 2<br>Datum<br>2 | 数据 3<br>Datum<br>3 | 数据 4<br>Datum<br>4 | 数据 5<br>Datum<br>5 | CRC16 校验码<br>Verification<br>Code | CRC16 校验码<br>Verification<br>Code |
|------------------------------|--------------------|--------------------|--------------------|--------------------|--------------------|--------------------|--------------------|-----------------------------------|-----------------------------------|
| 0x55                         | 0xFF               | 0x40               | 0x 00              | 0x 00              | 0x 00              | 0x 00              | 0x 00              | 0xCF                              | 0x1A                              |

数据 2 为 8 位有符号温度值

Datum 2 is 8 bit temperature valve with symbol

##### 2. 压力读取 Pressure Reading

| 起始字符<br>Initial<br>Character | 地址<br>Add<br>-ress | 命令<br>Com<br>-mand | 数据 1<br>Datum<br>1 | 数据 2<br>Datum<br>2 | 数据 3<br>Datum<br>3 | 数据 4<br>Datum<br>4 | 数据 5<br>Datum<br>5 | CRC16 校验码<br>Verification<br>Code | CRC16 校验码<br>Verification<br>Code |
|------------------------------|--------------------|--------------------|--------------------|--------------------|--------------------|--------------------|--------------------|-----------------------------------|-----------------------------------|
| 0x55                         | 0xFF               | 0x20               | 0x 00              | 0x 00              | 0x 00              | 0x 00              | 0x 00              | 0x6F                              | 0x13                              |

##### 返回值为 Returned Value

| 起始字符<br>Initial<br>Character | 地址<br>Add<br>-ress | 命令<br>Com<br>-mand | 数据 1<br>Datum<br>1 | 数据 2<br>Datum<br>2 | 数据 3<br>Datum<br>3 | 数据 4<br>Datum<br>4 | 数据 5<br>Datum<br>5 | CRC16 校验码<br>Verification<br>Code | CRC16 校验码<br>Verification<br>Code |
|------------------------------|--------------------|--------------------|--------------------|--------------------|--------------------|--------------------|--------------------|-----------------------------------|-----------------------------------|
| 0x55                         | 0xFF               | 0x20               | 0x 00              | 0x 00              | 0x 00              | 0x 00              | 0x 00              | 0x6F                              | 0x13                              |

数据 2 - 5 四个字节位 32 位浮点型数据，存储方式先低后高

Datum 2-5 are 32 bit floating point data, storage priority low to high

##### 3. 密度读取 Density Reading

| 起始字符<br>Initial<br>Character | 地址<br>Add<br>-ress | 命令<br>Com<br>-mand | 数据 1<br>Datum<br>1 | 数据 2<br>Datum<br>2 | 数据 3<br>Datum<br>3 | 数据 4<br>Datum<br>4 | 数据 5<br>Datum<br>5 | CRC16 校验码<br>Verification<br>Code | CRC16 校验码<br>Verification<br>Code |
|------------------------------|--------------------|--------------------|--------------------|--------------------|--------------------|--------------------|--------------------|-----------------------------------|-----------------------------------|
| 0x55                         | 0xFF               | 0x10               | 0x 00              | 0x 00              | 0x 00              | 0x 00              | 0x 00              | 0x9F                              | 0x16                              |

返回值为 Returned Value

| 起始字符<br>Initial<br>Character | 地址<br>Add<br>-ress | 命令<br>Com<br>-mand | 数据 1<br>Datum<br>1 | 数据 2<br>Datum<br>2 | 数据 3<br>Datum<br>3 | 数据 4<br>Datum<br>4 | 数据 5<br>Datum<br>5 | CRC16 校验码<br>Verification<br>Code | CRC16 校验码<br>Verification<br>Code |
|------------------------------|--------------------|--------------------|--------------------|--------------------|--------------------|--------------------|--------------------|-----------------------------------|-----------------------------------|
| 0x55                         | 0xFF               | 0x10               | 0x 00              | 0x 00              | 0x 00              | 0x 00              | 0x 00              | 0x9F                              | 0x16                              |

数据 2 - 5 四个字节位 32 位浮点型数据，存储方式先低后高

Datum 2-5 are 32 bit floating point data, storage priority low to high

#### 4. 地址设定 Address Setup

| 起始字符<br>Initial<br>Character | 地址<br>Add<br>-ress | 命令<br>Com<br>-mand | 数据 1<br>Datum<br>1 | 数据 2<br>Datum<br>2 | 数据 3<br>Datum<br>3 | 数据 4<br>Datum<br>4 | 数据 5<br>Datum<br>5 | CRC16 校验码<br>Verification<br>Code | CRC16 校验码<br>Verification<br>Code |
|------------------------------|--------------------|--------------------|--------------------|--------------------|--------------------|--------------------|--------------------|-----------------------------------|-----------------------------------|
| 0x55                         | 0xFF               | 0x61               | 0x 7A              | 0x 01              | 0x 00              | 0x 00              | 0x 00              | 0x48                              | 0xC4                              |

返回值为 Returned Value

| 起始字符<br>Initial<br>Character | 地址<br>Add<br>-ress | 命令<br>Com<br>-mand | 数据 1<br>Datum<br>1 | 数据 2<br>Datum<br>2 | 数据 3<br>Datum<br>3 | 数据 4<br>Datum<br>4 | 数据 5<br>Datum<br>5 | CRC16 校验码<br>Verification<br>Code | CRC16 校验码<br>Verification<br>Code |
|------------------------------|--------------------|--------------------|--------------------|--------------------|--------------------|--------------------|--------------------|-----------------------------------|-----------------------------------|
| 0x55                         | 0xFF               | 0x61               | 0x 7A              | 0x 01              | 0x 00              | 0x 00              | 0x 00              | 0x48                              | 0xC4                              |

数据 2 为要写入的 8 位地址

Datum 2 is 8 bit address to be entered.

#### 5. 地址读取 Address Reading

| 起始字符<br>Initial<br>Character | 地址<br>Add<br>-ress | 命令<br>Com<br>-mand | 数据 1<br>Datum<br>1 | 数据 2<br>Datum<br>2 | 数据 3<br>Datum<br>3 | 数据 4<br>Datum<br>4 | 数据 5<br>Datum<br>5 | CRC16 校验码<br>Verification<br>Code | CRC16 校验码<br>Verification<br>Code |
|------------------------------|--------------------|--------------------|--------------------|--------------------|--------------------|--------------------|--------------------|-----------------------------------|-----------------------------------|
| 0x55                         | 0xFF               | 0x74               | 0x 7A              | 0x 00              | 0x 00              | 0x 00              | 0x 00              | 0x71                              | 0xC7                              |

返回值为 Returned Value

| 起始字符<br>Initial<br>Character | 地址<br>Add<br>-ress | 命令<br>Com<br>-mand | 数据 1<br>Datum<br>1 | 数据 2<br>Datum<br>2 | 数据 3<br>Datum<br>3 | 数据 4<br>Datum<br>4 | 数据 5<br>Datum<br>5 | CRC16 校验码<br>Verification<br>Code | CRC16 校验码<br>Verification<br>Code |
|------------------------------|--------------------|--------------------|--------------------|--------------------|--------------------|--------------------|--------------------|-----------------------------------|-----------------------------------|
| 0x55                         | 0xFF               | 0x74               | 0x 7A              | 0x 00              | 0x 00              | 0x 00              | 0x 00              | 0x35                              | 0xC7                              |

数据 2 为从机地址

Datum 2 is slave address.

